



Coda Audio C5 DSP amplifier User Guide version 1





Important Safety Information

Please read carefully and keep the following instructions and safety information. Heed all warnings and follow all instructions.

- **Do not remove covers. There are no user serviceable parts inside; please refer servicing to qualified service personnel.**
- **This equipment must be earthed.**
- Protect the power cord from being walked on or pinched, particularly at plugs, convenience receptacles and the point where they exit from the apparatus.
- Only use attachments/accessories specified by the manufacturer.
- Servicing is required when the apparatus has been damaged in any way, such as the power supply cord or plug is damaged, liquid has been spilled or objects have fallen into the apparatus, the apparatus has been exposed to rain or moisture, does not operate normally, or has been dropped.

Regulatory Compliance

This product complies with both the EMC Directive (89/336/EEC) and the Low Voltage Directive (73/23/EEC) as issued by the Commission of the European Community.

Compliance with these directives imply conformity with the following European standards:

- EN60065 Product safety
- EN55103-1 Electromagnetic Interference (Emission)
- EN55103-2 Electromagnetic Susceptibility (Immunity)

This product is intended for operation in the E2 (commercial & light industrial) and E3 (urban outdoors) Electromagnetic Environments.





Table of Contents

Important Safety Information	2
Regulatory Compliance	2
Thanks and Unpacking	5
Introduction and Key Features	6
Front Panel	13
Power Switch	13
Power ON indicator	13
Bridged Mode indicator	13
Control Software Online indicator	13
Protect	14
User DSP indicator	14
User DSP Setting Defeat button	14
Input Signal Indicators	14
Rear Panel	15
Power Inlet	15
Audio Input Connectors	15
Audio Output Connectors	15
Communications Port Connections	16
Mechanical Installation	7
AC Power Connection	9
Audio Connections	10
Using unbalanced connections	11
Amplifier output connections	11
100V line operation	12
C-Net Amplifier Control Panel	17
Amplifier Channels	18
User Controls	18
Monitoring Section (MonIcon)	19
User DSP	19
Main Control Panel	20
Hidden Controls	22
Saving & Recalling Data	22
Loading Factory Presets	22
Tool Bar	23
Keyboard Shortcuts	23
Audio Processing	24
Equalisation Filters	25
Bridge Mode	25
Protection	26
Limiters	26
Indication	25





EQ and Filter Response Graphs.....	27
Signal Processing Block Diagram	30
Technical Specifications.....	31





Thanks and Unpacking

Thank you for choosing a Coda Audio C5 DSP amplifier system for your application. Please spare a little time to study the contents of this manual, so that you obtain the best possible performance from this unit.

All Coda Audio products are carefully engineered for world-class performance and reliability. If you would like further information about this or any other Coda Audio product, please contact us. We look forward to helping you in the near future.

Unpacking the Coda Audio C5 DSP amplifier

After unpacking the unit, please check carefully for damage. If damage is found, please notify the carrier concerned at once. You, the consignee, must instigate any claim. Please retain all packaging in case of future re-shipment.





Introduction and Key Features

Introduction

The C5 DSP amplifier systems from Coda Audio integrate light-weight power supplies, high power sonically transparent class D amplifiers, complete system monitoring and a fully featured USB or network controlled 24 bit 96kHz DSP processing platform as standard.

Key features

- One or two dual amplifier sections : two or four channels
- Each section is completely independent with discrete PSU, amplifier and DSP
- Fully featured PC control and telemetry of single devices or networks as standard
- Coda Audio class leading Class D amplifier stages
- Minimal signal path and refined DSP algorithms for clean, dynamic and musical audio performance





Mechanical Installation

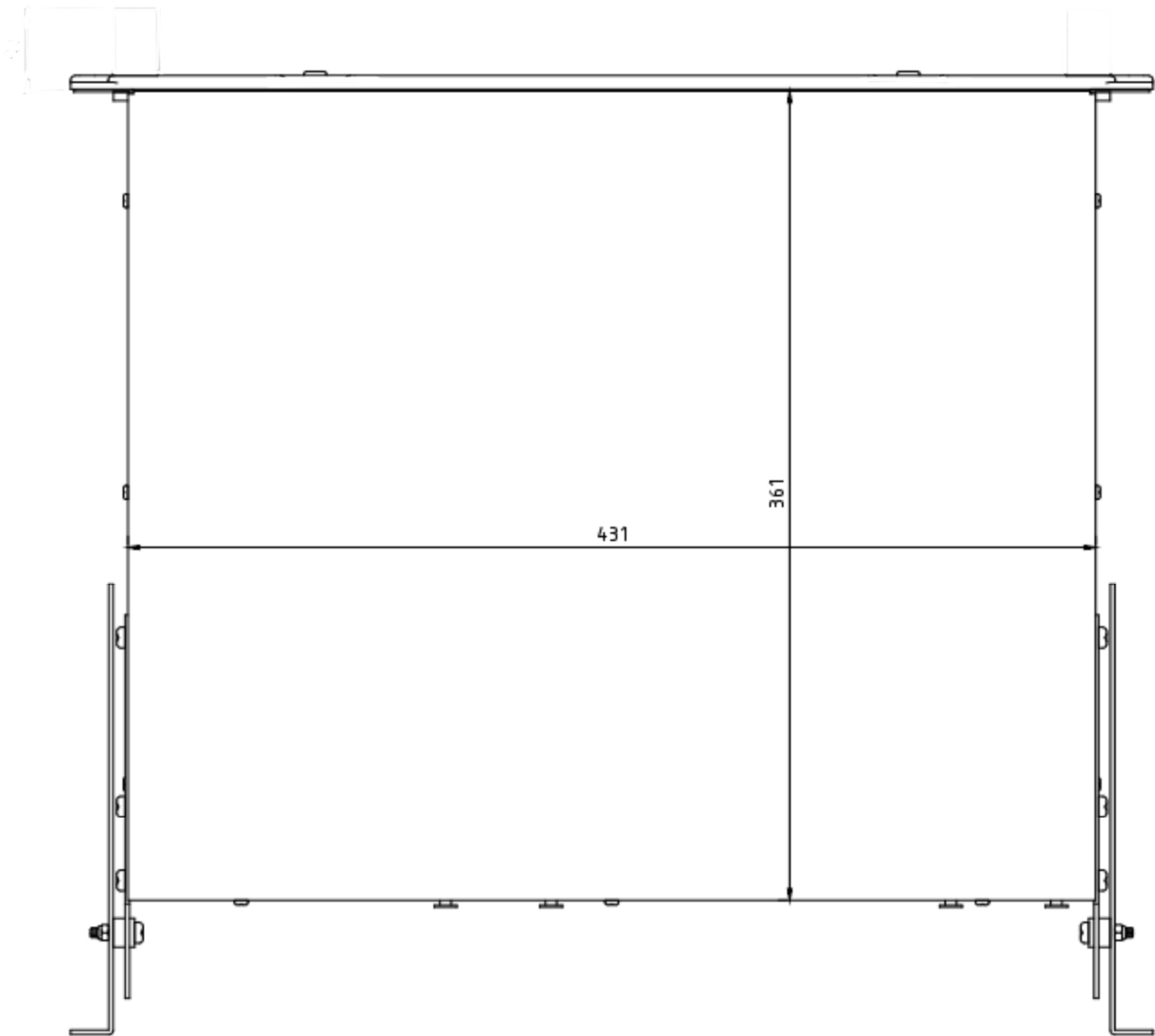
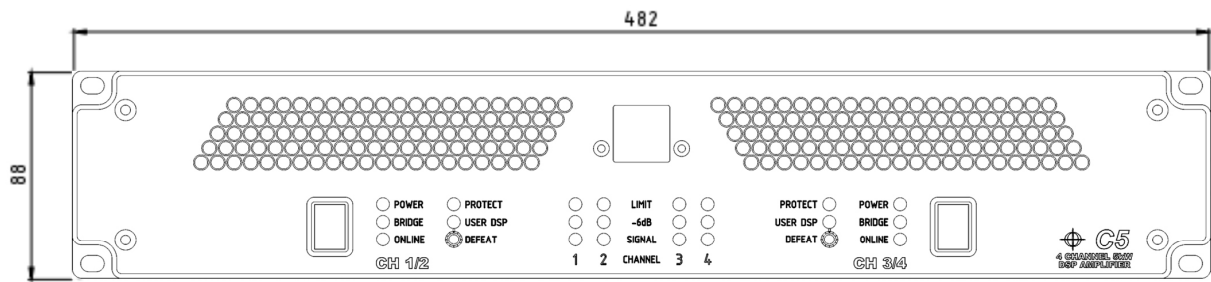

The C5 DSP amplifier system is designed to be mounted in a standard 19" rack enclosure. Where the amplifier is used in a fixed installation, it is possible to use only the front panel 19" rack mounting holes to mount it in a standard rack enclosure. If the amplifier is mounted in a mobile rack it is recommended that the rear rack mounting kit is fitted so





the amplifier can be well supported. Damage caused by insufficient support is not covered by the warranty.

To prevent damage to the front panel it is recommended that plastic cups or washers are fitted underneath the rack mounting bolt heads.

It is possible to mount multiple C5 amplifiers without ventilation gaps between them but it is essential that an unobstructed flow of clean air is available from the back of the unit to the front. It is important that neither the air intakes at the rear of the unit or the exhaust vents at the front are covered.

The amplifier should never be exposed to rain or moisture during operation or storage. If the unit does come into contact with moisture, remove the AC power cord immediately and leave it in a dry and warm location to dry out.

Note that when any equipment is taken from a cold location into a hot humid one, condensation may occur inside the device. Always allow time for the equipment to attain the same temperature as its surrounding environment before connecting the AC power cord.





AC Power Connection

WARNING! THIS APPLIANCE MUST BE GROUNDED.

The amplifier must always be connected using a 3-wire, grounded AC supply. The framework of the rack mount enclosure should also be connected to the same grounding circuit. The unit should never be operated unless the AC power cable ground is correctly terminated; this is important for personal safety and for control of the system grounding.

The amplifier is supplied with a Neutrik PowerCon™ type locking AC power connector. Use only an AC power cord with a correctly terminated PowerCon™ type connector to make the connection to the mains power supply.

The C5 amplifiers are designed to operate on 50/60 Hz AC power. The power supply sections automatically configure themselves for either 115V or 230V nominal voltage at turn on. The amplifiers will operate over an extended range of supply voltages from; nominal 115V / 230V +/- 10%.

Note that whilst the amplifier will operate correctly at voltages indicated, the specified output power will only be achieved when operating with the stated nominal voltages.





Audio Connections

For each amplifier channel there are female and male XLR input connectors which are wired in parallel. Typically the female connector is used for the audio input, the male XLR connector being available to link the same audio signal to another amplifier channel.

The HOT, + or 'in phase' connection should be made to pin 2 of the XLR connector.

The COLD, - or 'out of phase' connection should be made to pin 3 of the XLR connector.

Pin 1 of the XLR connectors is internally connected to the chassis. The screen of the input cable should always be connected to one of these points to ensure that EMC performance and regulations are met. The cable shield ground should also be connected to the source device which is providing the input signal to the amplifiers.

Input XLR balanced connection

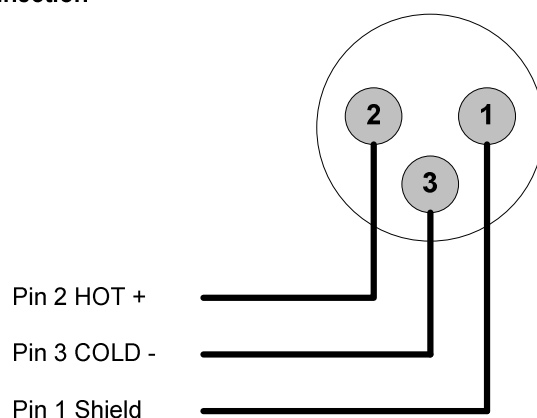



Using unbalanced connections

When connecting the C5 amplifier to an unbalanced audio source, the signal conductor should be terminated to XLR pin2 and the cable screen terminated to both pins 1 and 3.

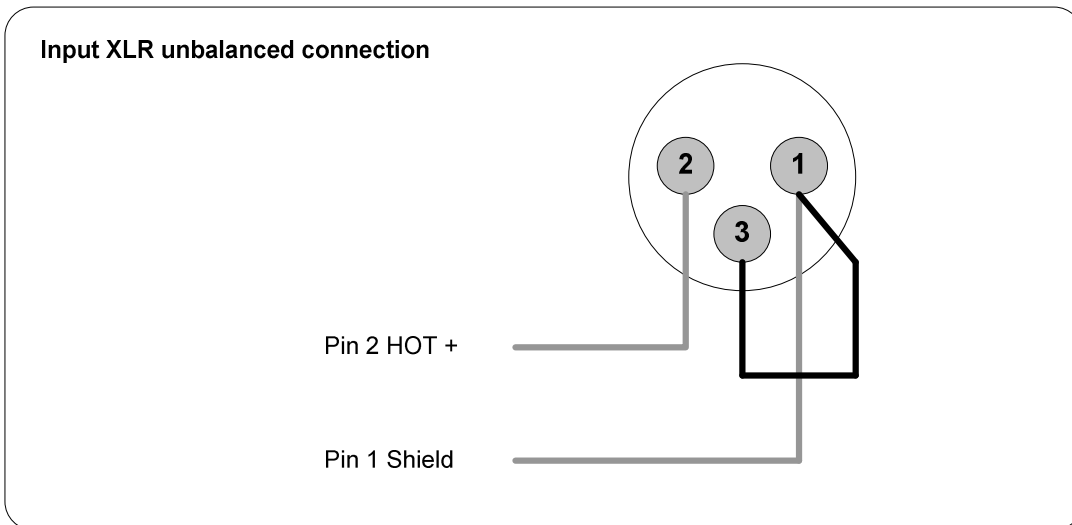

In bridged mode output channel 1 signal chain provides the signal for the 1 & 2 pair of amplifier channels, output channel 3 signal chain provides the signal for the 3 & 4 pair.

Amplifier output connections

The C5 amplifier is fitted with one Speakon™ connector per amplifier channel. The appropriate conductor terminations are shown below and on the rear panel of the unit.

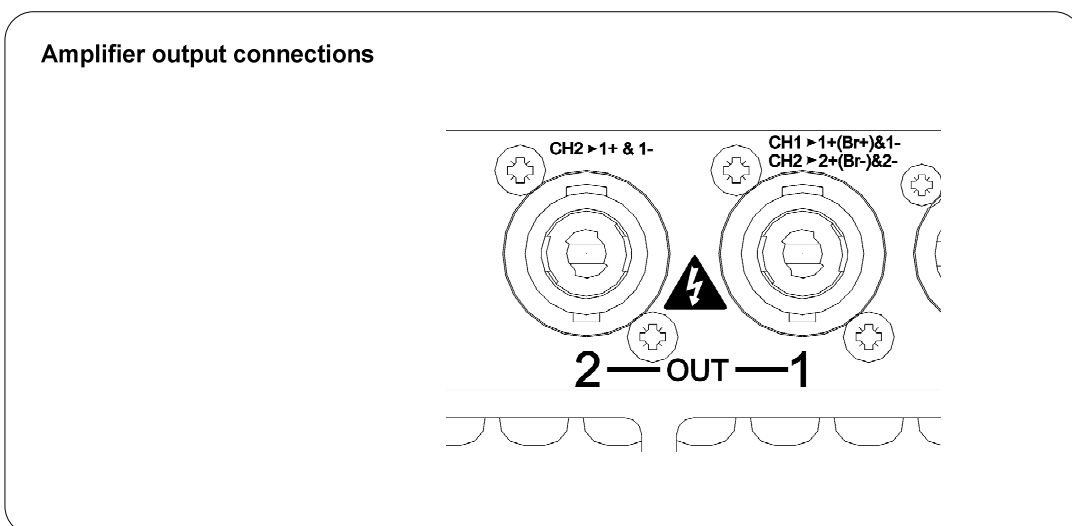

The Speakon™ connector for amplifier channel 1 carries the output for amplifier channels 1 and 2. In addition this connector can also be used if the pair of amplifier channels is being operated in bridged mode.





More than one speaker can be connected to each channel provided the total impedance per channel is not less than **2 ohms**. In bridged mode the minimum total impedance should not be less than **4 ohms**.

100V line operation

A single channel of an C5 can deliver 1250W in to 2 Ohms, therefore the RMS voltage at the speaker terminals when delivering this will be $\sqrt{(1,250 \times 2)} = 50V$.

If each channel is not loaded to full capacity of 1,250W (typically a 70V / 100V application will not load it this heavily) then the voltage will be higher than this because the power rails will not be sagging so much; approximately 60V.

Dependent on which voltage you use, a single channel will drive a 70V line to within either 3dB or 1.3dB of maximum and it will drive a 100V line to within 6dB or 4.5dB of maximum.

A bridged pair of channel can deliver 2,500W in to 4 Ohms which equates to an RMS voltage of 100V or approximately 120V with a lower load than the full 2,500W.

Dependent on which voltage you use with a bridged pair of channels, the C5 will be able to overdrive a 70V line by either 3dB or 4.7dB and a 100V line being driven perfectly or overdriven by 1.6dB.





Front Panel

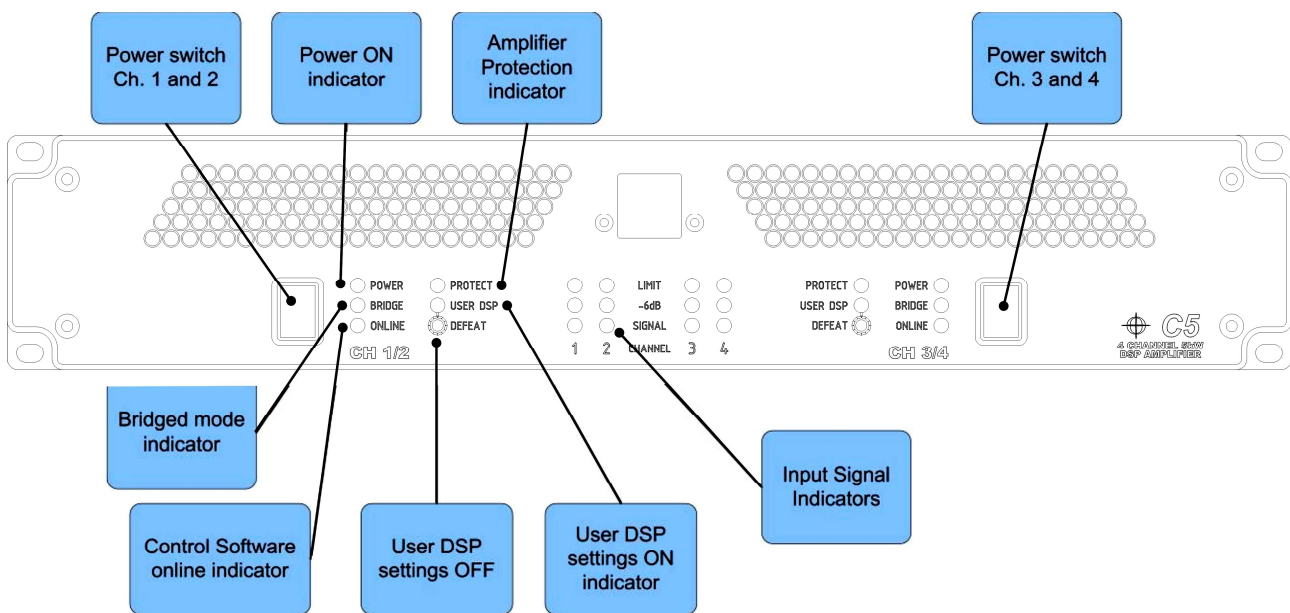

Power Switch

The C5 amplifier is fitted with either one or two dual channel power modules. As the power modules operate independently there is a separate power switch for each. When the power switch is operated, the protect indicator will flash while the DSP and amplifier control systems are prepared. After approximately 3-4 seconds the amplifier will be operational and the audio level is gradually ramped up.

Power ON indicator

Each Power Switch is associated with a POWER indicator. This green indicator is lit when power is applied and the power switch is in the ON position.

Bridged Mode indicator

It is possible to use the dual channel power modules in Bridged Mode. This is enabled using the C-Net PC control application. Further details on Bridge Mode can be found in the C-Net control section of this user mode.

Control Software Online indicator

A network of C-Net compatible products including the C5 range of DSP amplifiers can be controlled, configured and monitored using the C-Net PC application. The Online indicator will light when the amplifier is correctly connected to C-Net.





Protect

The C5 DSP amplifier system has sophisticated protection and monitoring systems which keep the amplifier within its safe operating window whenever possible. This indicator lights when the protection systems are active in any way.

User DSP indicator

Using the C-Net PC application the user can introduce audio processing such as EQ, gain and delay. These settings can be bypassed using the User DSP settings defeat button. The indicator will be lit when these DSP settings are in use.

User DSP Setting Defeat button

This button allows the user to bypass the user DSP settings; its status is shown by the User DSP indicator.

Input Signal Indicators

A set of three pairs of indicators show signal present, 6dB below limit, and limit for each channel. The signal present indicators operate at approximately 50 dB below maximum output, giving a useful indication of even relatively low input signal levels. The -6dB indicators are intended to show when the output is almost at maximum level. The Limit indicators warn the user that the output has reached maximum and that the signal limiters are now constraining the output.





Rear Panel

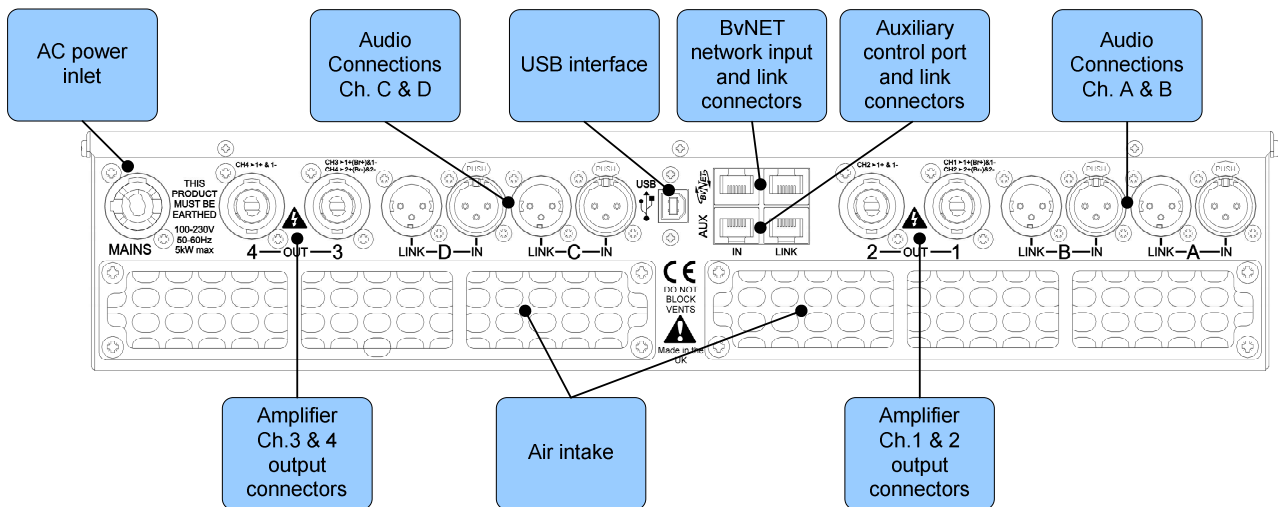

Power Inlet

The C5 amplifier should be connected to a suitable mains electricity supply using the cable supplied. The unit uses auto ranging switch mode power supplies which are capable of operating with a nominal mains voltage of either 115V or 230V, 50/60Hz without re-configuration.

Audio Input Connectors

All audio connections are fully balanced and wired pin-1 ground, pin-2 hot & pin-3 cold. The two inputs have pin-1 connected directly to the chassis and feed the signal processing chains. If an unbalanced source is used, a connection should be made between the pin-3 'cold' signal and the ground connection of the unbalanced source.

Audio Output Connectors

Each amplifier pair has two speaker outputs.

There are two Neutrik Speakon™ connectors for each amplifier pair:

Speakon 1 (or 3) carries both channel 1 (or 3) and channel 2 (or 4) outputs

Speakon 2 (or 4) carries channel 2 (or 4) output

For non-bridge connections, use Speakon 1 (or 3) for the first speaker, and Speakon 2 (or 4) for the second speaker. Use pins 1+ and 1-.





Or alternatively, if you want to have one cable feeding two speakers, use Speakon 1 (or 3) pins 1+ and 1- for the first speaker, and pins 2+ and 2- for the second speaker.

For Bridge operation, use Speakon 1 (or 3) pins 1+ and 2+ (1+ for Speaker + and 2+ for speaker -)

Communications Port Connections

Coda Audio C5 DSP amplifiers may be controlled and monitored using the C-Net PC application. There are two ways of connecting your computer to the C5:

- 1 – Using the **USB** socket (when you want to connect your computer to just one C5)
- 2 – Using the **C-Net network** sockets (when you want to control several products)

When using the C-Net sockets, you will need to use a C-Net Interface accessory to allow your computer to communicate with the C-Net network.

Before connecting a USB port from your computer to either the USB socket on C5, or to a C-Net Interface, you will *first* need to run the USB driver installation utility which you will find on the CD-ROM supplied with this product, or may be downloaded from

www.codaaudio.com

Once the USB driver utility has been installed, you can then plug in your USB lead from your computer. With operating systems such as Vista or Windows7, you should not need to intervene in any way. With other operating systems (such as XP), you will need to go through the USB driver installation process which will initiate when you plug your USB cable in. This generally involves accepting the default answers. For further help on this process, please see the USB driver installation notes on the CD-ROM or on the website.

When using the C-Net Network, you should connect from a Link socket on one device to the In socket on another device. The C-Net network may be 'daisy chained' in this way through as many devices as you require (although a sensible limit would be perhaps 24 devices, after which you should consider using more than one C-Net Interface to create more than one sub-network). A C-Net network can have a total length of up to 1km using





Cat5 cable. If you are using USB to connect to the C-Net Interface, then the Interface will usually power itself via USB. However, if you are using RS232, or if you are using an unpowered USB hub, or you have some network powered C-Net network equipment in the network, then you will need to use an Accessory Power Supply to power the Interface.

The **Aux In** socket may be used to select between a number of 'Voices' that may have been programmed into the C5 using factory files (*.dfa) supplied Coda Audio. These files would be loaded into the C5 via the C-Net application. Coda Audio will give you details of how to make connections to the Aux port when using their factory files. The currently selected Voice is indicated on the C-Net panel. The **Aux Out** socket allows you to chain the Aux connections on to further C5 so that the same voice selection is done on all of them. There is no practical limit to the number of C5 that may be chained together via the Aux sockets.

Please note that although the C-Net and the Aux ports are standard RJ45 sockets, these are not Ethernet. Do not connect these to Ethernet equipment.

C-Net Amplifier Control Panel

The C5 amplifier is shipped with standard settings in the Digital Signal Processor (DSP) so it will function in the same way as any 'standard' amplifier without on-board processing.

However each two channel amplifier section contains a fully featured DSP which can be configured to process the audio signals as required for a given application or loudspeaker system. In addition to the digital processing the amplifiers also provide complete telemetry and status information.

The powerful and easy to use C-Net PC application provides control and monitoring of one unit or a whole network of devices.

C-Net and related driver software are provided on the CD which comes with the C5 amplifier or can be downloaded free from:

www.codaudio.com





This section of the user guide explains the functions of the C-Net control panel for the C5 DSP amplifiers. For further help and information on the main C-Net application please click on the help button on the main application. For more detailed help about the C5 control panel, click the "?" in the right-hand corner of the C5 control panel in C-Net.

Amplifier Channels

It is important to realize that each two channel amplifier section contains its' own DSP. So a four channel amplifier is logically split into two sections, each with two channels. There

is an independent two channel control panel associated with each section. Each section will appear in C-Net as an independent 'device' in the Network Tree.

The Tree will add the Device Name with the Role Number for each of the sections in square brackets. The Role Number 1 section is for Channels 1 and 2, and Role Number 2 for channels 3 and 4.

The descriptions of the C-Net control panel therefore relate to a 2-channel section.

The amplifier has two or four inputs and two or four outputs. There is not necessarily a 1:1 correspondence between inputs and output because the routing between inputs and outputs may be changed; either by you or by Coda Audio (see the Hidden Controls section for more details). For example, one input may be used to feed two outputs.

User Controls

The control panel for the DSP amplifier allows the parameters to be viewed and adjusted. The panel may have one of two different formats: A monitoring panel (the 'MonIcon') where the status of the amplifier may be viewed, or a full control panel where all the controls to adjust parameters are located. The full panel has a 'tabbed' area which allows you to choose from a number of different areas of interest.

There are some controls such as mute, which are displayed constantly; the remaining parameter controls being organised into tabbed groups depending upon function.





Monitoring Section (MonIcon)

This allows you to view what is going on inside the amplifier at a glance. There are input signal level meters showing the input signal level on each input, signal level meter(s) for each output which indicate signal level relative to the limiter setting for each output, a thermal meter giving an impression of the temperature inside the amplifier, an amplifier status indicator showing when an amplifier is protecting itself from damage due to abnormal operating conditions, and Driver indicator(s) showing when the impedance of a driver is outside normal range. Generally, the indicators show **green** whilst all is well and **red** when something is wrong.

You may also mute the amplifier inputs using the mute buttons. You can change the view to the main panel by clicking the ">>" button.

User DSP

The amplifier can either use:

- Factory settings determined entirely by the Factory preset file from Coda Audio (called "Factory voice") – see [Loading Factory Presets](#), or
- Your own settings (called "User voice") which overlay these basic factory settings.

A recessed Defeat button on the front of the amplifier allows you to select between Factory and User DSP settings. Click the button to toggle between these two modes. When the User DSP indicator is off, the amplifier is in Factory voice. In the Factory voice, you cannot change any of the settings; they are fixed by Coda Audio (and thus are a safe 'fallback' if something goes wrong with your settings). Only when the indicator is on will changes you make in C-Net be heard. Note however that if you make adjustments on the C-Net control panel when the amplifier is set to Factory voice, the settings are changed and stored in the amplifier, but you will not be able to hear the changes until the button is set to User DSP. A red warning message will be shown on the C-Net panel when in Factory voice.

An indicator at the top of the C-Net panel to the right of the status indicators also shows the Voice setting of the amplifier (Voice 1 – User, or Voice 2 - Factory).

If you wish to make the amplifier entirely secure from tampering, you can disable the User DSP button by ticking the "Disable User Defeat Button" tickbox on the Properties / Options





tab of the C-Net control panel. This locks the amplifier into the User Voice regardless of the setting of the push button.

Also see [Loading Factory Presets](#) and [Aux In Port](#)

Main Control Panel

The Input area allows you to adjust the input sensitivity of each input of the amplifier, and to change the polarity of each input, allowing you to reverse the phase of the loudspeakers fed from that input.

The Output section allows you to control the output drive level of each amplifier. Also, depending on which parameters have been hidden by Coda Audio, you may also be able to:

- Adjust the routing from inputs to outputs (allowing you for example to feed two outputs from one input). Regardless of hiding, you will always be able to see the routing in use
- Control Bridge mode (see Bridge Mode)
- Adjust the protection limiters (see Limiters).

The EQ / Delay tab(s) allows you to adjust the equalization, High-pass and Low-pass filters, and delays.

The equalization allows you to adjust the frequency and Gain (boost/cut) for each of the equalization filters, and the bandwidth of the parametric equalisers. The latter controls allow the responsiveness of the filters to be adjusted either as Octaves or Q, depending on the setting of Preferences>Show Bandwidth As. There is also a Low-shelf and a High-shelf filter, each with Frequency, Slope and Gain controls.

A 'Frequency Response' curve shows the shape of each filter individually (by colour), and the combined effect of all equalization (in white).





The Properties/Options tab contains some properties of the amplifier. Here, you can enter a name for the amplifier (such as "Left Fill"). Also viewable in this tab are the model name of the amplifier, and the name of the settings provided by Coda Audio of the factory file. The Maintenance area shows some details of how the amplifier has been used and the amount of protection the amplifier is applying.

The Logs area contains graphs of events against time, recording events over a period of up to three days. Since the amplifier cannot record any events whilst powered-off, breaks in a log due to power-downs are indicated by a break symbol || in the log. The events recorded are: Thermal, which is the used thermal capacity, Protection, which is a measure of how much the amplifier is 'dimming' itself in order to protect itself from potential damage, and peak output current for each output. The data in the log can be exported by right-clicking on the log to launch a context menu, and selecting "copy log data to clipboard". The data could then be pasted into a spreadsheet for further analysis. Your dealer may ask you to do this if you have experienced a problem.

The Power button allows the amplifier to be put into power saving mode when it is not being used. The associated Auto Power Save Time control allows the amplifier to automatically go into power-save if no audio signal has been detected for a period of time.

This function can be defeated by setting the latter control to Manual. We would strongly advise leaving it set to automatic however. There is no negative consequence to doing this since 'wake-up' on detecting the presence of an audio input signal is instantaneous.

You can change the view to the MonIcon panel by clicking the "<<" button.





Hidden Controls

Coda Audio may have hidden some of the controls on the panel in order to maintain proper protection of the connected loudspeakers. Such hidden controls will appear grey and cannot be adjusted.

Saving & Recalling Data

Device Data may be saved to disk or opened from disk. C-Net Device Settings files (with file extension .dse) contain all the data necessary to restore a device to exactly the same state as when the file was saved.

If the current settings have been changed since the last file save or file open, the Save Icon on the panel toolbar will be shown in solid colour. If the settings are already safe, the Save icon appears grey.

If a file is opened when on-line to devices, the new data will be sent to the device, overwriting whatever was in the device. A warning will be given before this is done. Data saved from one device can be reopened in another to save time inputting data. (Assuming settings are to be duplicated)

C-Net will always try to protect your data, warning you if you are attempting an action that could cause loss of data.

Loading Factory Presets

Coda Audio will provide you with one or more 'preset library' files which contain settings for specific loudspeakers. These take the form of Factory files (Device Factory files (with file extension .dfa)).

When you load preset factory settings into this type of device, the current user settings will be preserved since the factory settings will only overwrite the default factory DSP settings rather than the User DSP settings. However, routing (source selection), Limiter thresholds and Bridge mode become overwritten by the values in the factory file, even if Coda Audio has allowed you to edit these.



For further information on loading factory settings, please refer to the C-Net application  main help.

Tool Bar

The toolbar provides the following one-click functions:

Open

Opens a file which contains parameters for the device. A dialogue will appear, inviting you to choose a file to open.

Save

Saves the current settings. A dialogue will appear inviting you to enter a file name. If the settings have not changed since you last saved or opened a file, the Icon will appear greyed out, indicating that a save is not necessary.

Locate

Flashes the Online indicator on the amplifier section to assist device identification, and as a quick check that communications are working. This only works when on-line.

Help

Launches Panel Help

Keyboard Shortcuts

C-Net supports the following 'shortcuts':

Tab Move to next control

In value boxes:

CTL+C Copy

CTL+V Paste

CTL+X Cut

CTL+Z Undo

On Drop-down, Spin, Push, Fader and radio controls:

PgUp Increase value (coarsely)





PgDown	Reduce value (coarsely)
Up/Right arrow	Increase value (finely)
Down/Left arrow	Reduce value (finely)

On push-button controls:

Space	Activate
-------	----------

Audio Processing

The Digital Signal Processor (DSP) within the amplifier does all the necessary processing (such as crossover filtering, driver equalization and power limiting) for the loudspeaker to give you a solution which operates well in most circumstances without the need for further user adjustment (apart from gain). The user may however apply further processing to optimize the amplifier for a given application.

The following user processing is available:

High-pass/Low-pass filtering with frequency variable over the range 20Hz to 25kHz (and 'Out') with the following alignments:

1st order

12dB/Octave Bessel

12dB/Octave Butterworth

12dB/Octave Linkwitz-Riley

18dB/Octave Bessel

18dB/Octave Butterworth

24dB/Octave Bessel

24dB/Octave Butterworth

24dB/Octave Linkwitz-Riley

A 2nd order low-shelf filter with frequency variable over the range 10Hz to 25kHz, and boost/cut from -15 to +15dB, and slope from 6 to 12dB/Octave.



A 2nd order high-shelf filter with frequency variable over the range 10Hz to 25kHz, and  boost/cut from -15 to $+15$ dB, and slope from 6 to 12dB/Octave.

Eight bands of parametric equalizer, each band having frequency variable over the range 10Hz to 25kHz, bandwidth variable from 0.18 to 5.6 octaves (Q 0.15 to 8.1), and boost/cut from -15 to $+15$ dB.

Delay adjustable up to 90ms.

Adjustable input gain from -30 to $+15$ dB, mute and polarity.

Adjustable output gain from -30 to $+15$ dB.

Equalisation Filters

The eight parametric equalisation filters may each be used to emphasize (by applying a positive Gain parameter setting) or de-emphasizing (by applying a negative Gain parameter setting) a range of frequencies centered on the setting of the Frequency parameter, and encompassing a frequency range determined by the Bandwidth parameter setting.

The two shelving filters allow all frequencies below that of the frequency parameter (for the Low shelf) or all frequencies above that of the frequency parameter (for the high shelf) to be emphasized (by applying a positive Gain parameter setting) or de-emphasized (by applying a negative Gain parameter setting).

The ten filters are used in combination to achieve the desired response across all frequencies.

Bridge Mode

When the amplifier is set to Bridge Mode, it uses two amplifier channels to drive one loudspeaker with greater power. In this mode, there is only one set of Output controls per pair of amplifier channels since both of the amplifiers in the pair are driven with the same signals, as determined by the channel 1 (or channel 3) controls.





Protection

Comprehensive protection features preserve the longevity of the loudspeaker and amplifier by continuously monitoring several critical parameters, and reducing the gain, or muting the amplifier either temporarily or permanently depending on the nature and seriousness of the fault or misuse. The amplifier will recover and restart if at all possible, but may remain in shut down if a serious fault persists.

Limiters deal with routine over-driving of the amplifier, making sure that the driver(s) are not pushed too hard. The limiter indicator(s) will warn you when the driver is being driven into limit.

Minor faults are dealt with by 'dimming' the amplifier, reducing the level to a sufficient degree and for a sufficient time that the amplifier is able to recover gracefully without any user interaction. When the fault condition has passed, the amplifier will recover automatically.

More serious faults may cause the amplifier to mute while it recovers, after which it will automatically re-energize, again without user interaction. If such a fault is found to be persistent however, the amplifier is shut down permanently. A power cycle by the user is then required.

Limiters

Coda Audio may have allowed you access to the Limiter threshold settings. These settings require careful adjustment in order to protect your loudspeakers. Please refer to Coda Audio for advice on the appropriate settings to use. Note that a setting of 0dB on the limiters equates to +36.8dBu = 53.8Vrms (or +42.8dBu, 107.7Vrms in bridge mode). The equivalent RMS voltage at the output is also shown under the Threshold controls.

For further help on the C-Net application, click the help button on the main application.





EQ and Filter Response Graphs

The following plots show the attenuation characteristics of the various crossover filters available within the C5. These are all shown at a crossover frequency of 1kHz.

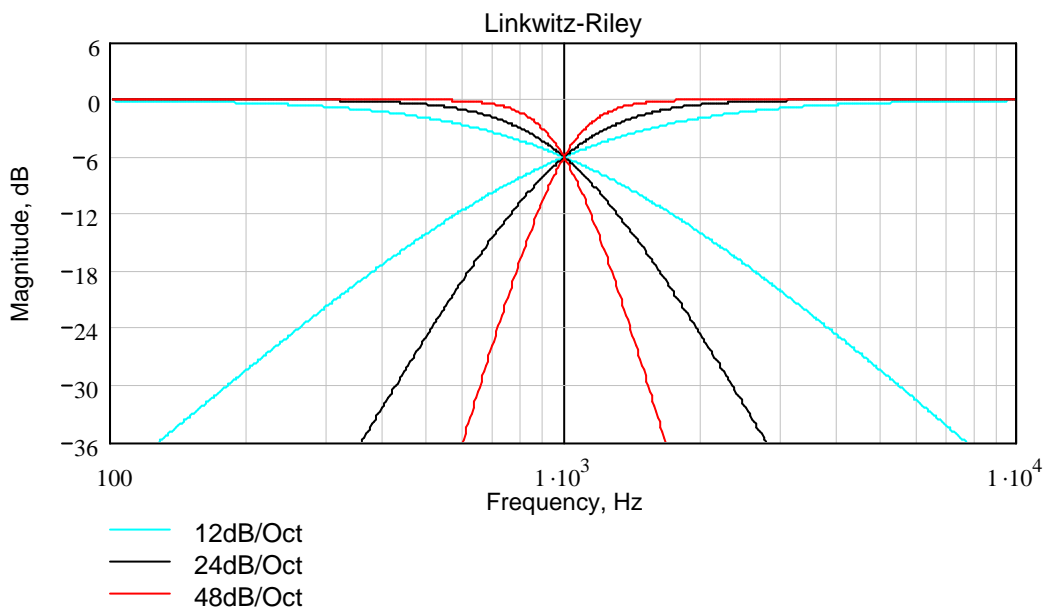
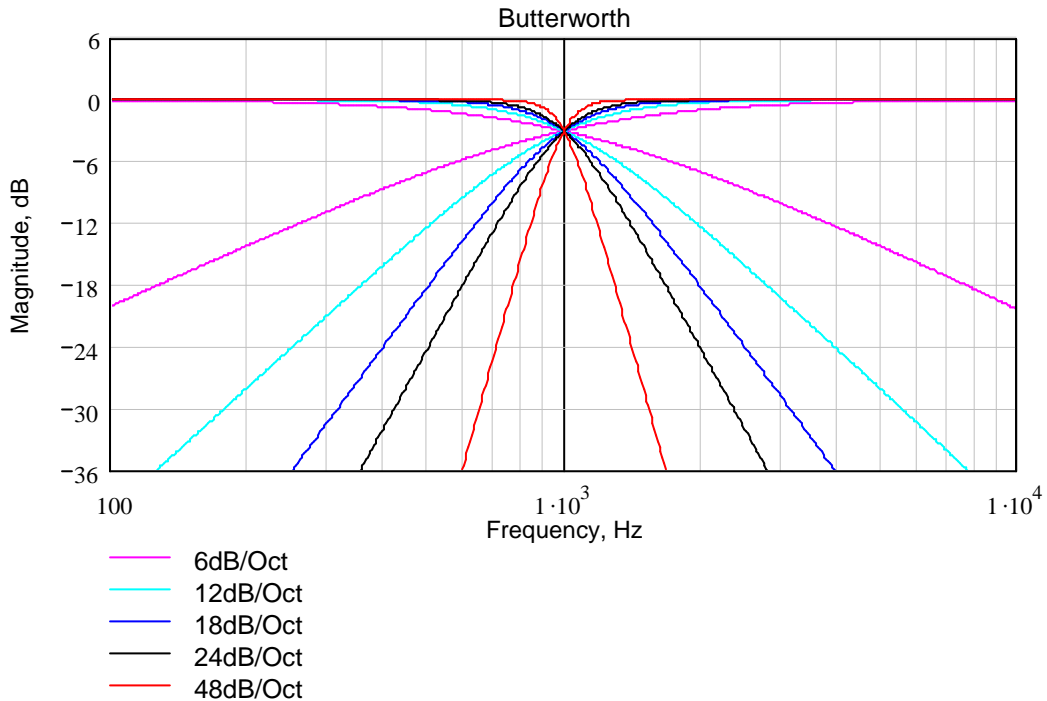

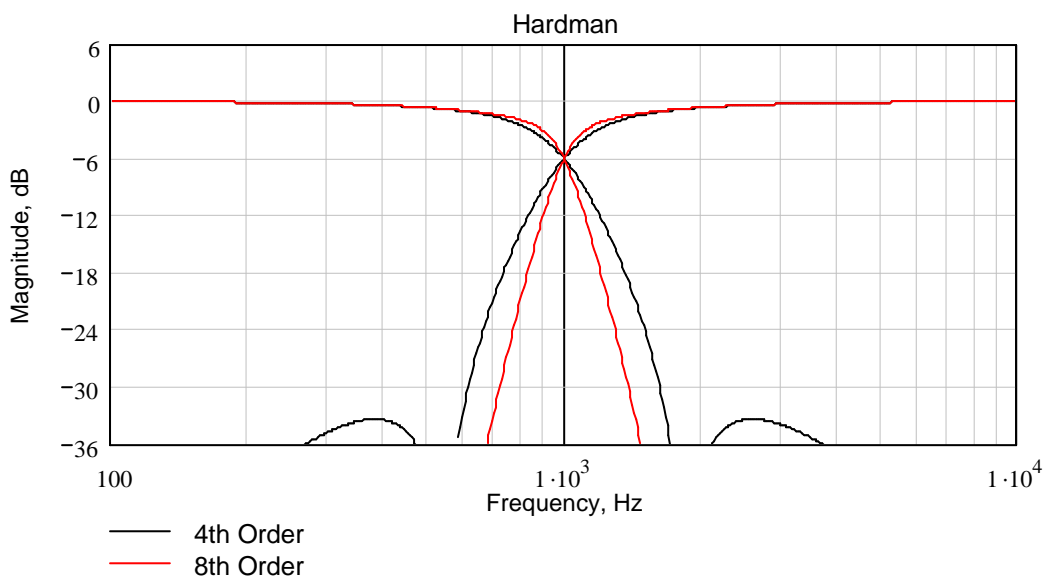
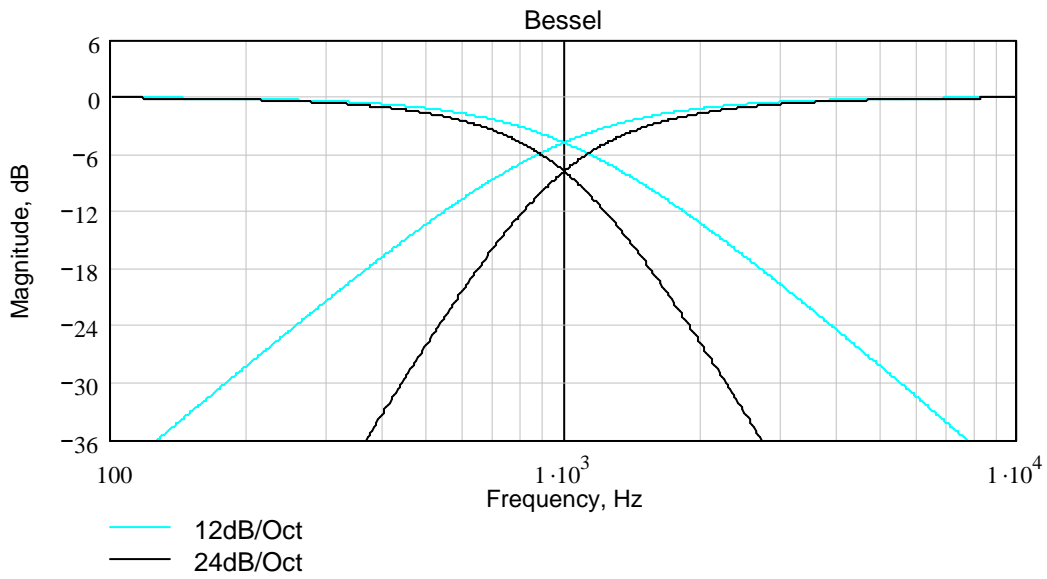



The following plots show the magnitude response (frequency response) characteristics of the various equalization filters available within the C5. These are all shown at a frequency of 1kHz.

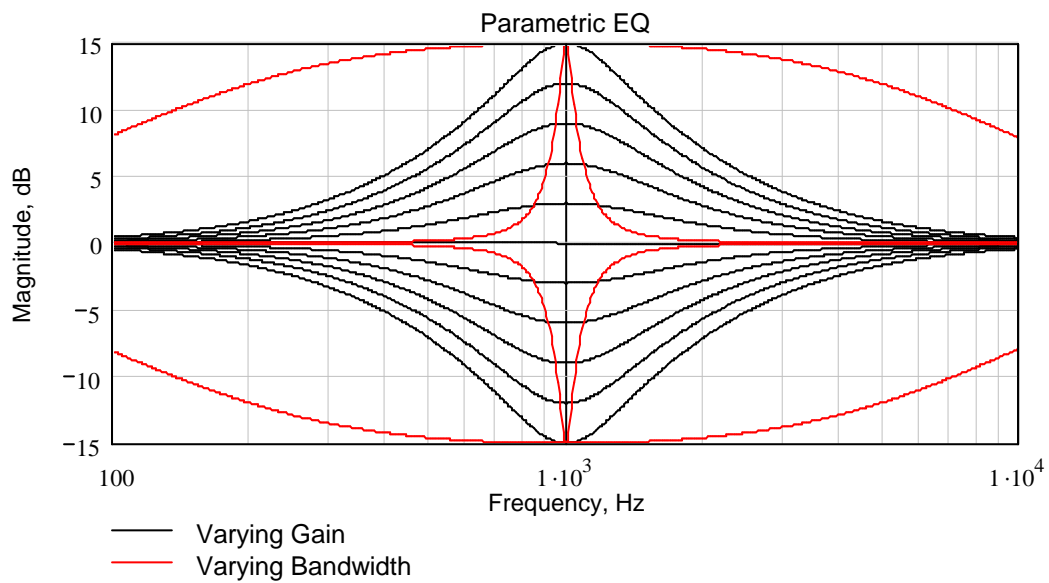
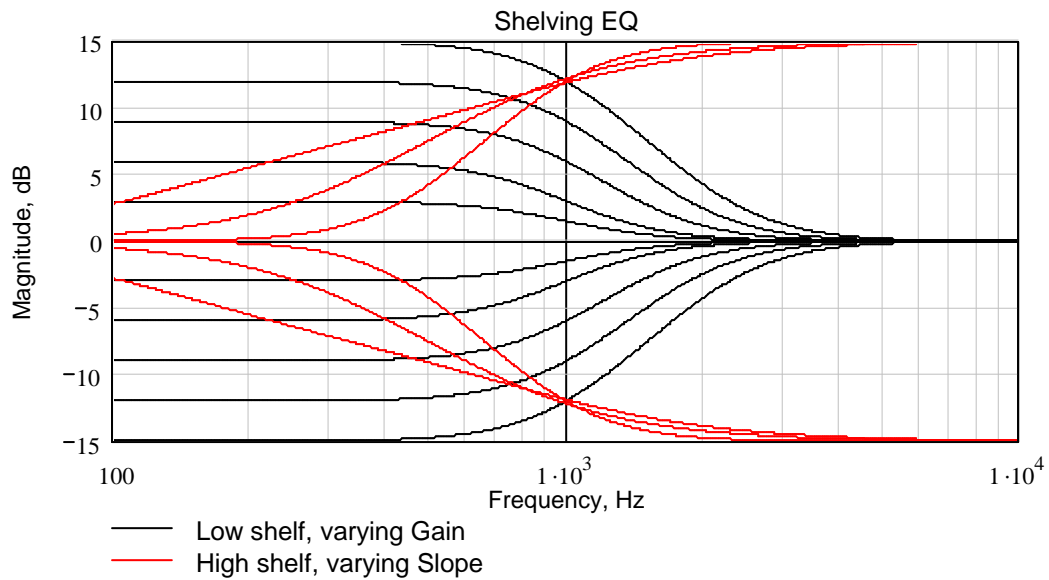



Signal Processing Block Diagram

Please note that each C5 contains two of these processing blocks, one for each pair of channels.

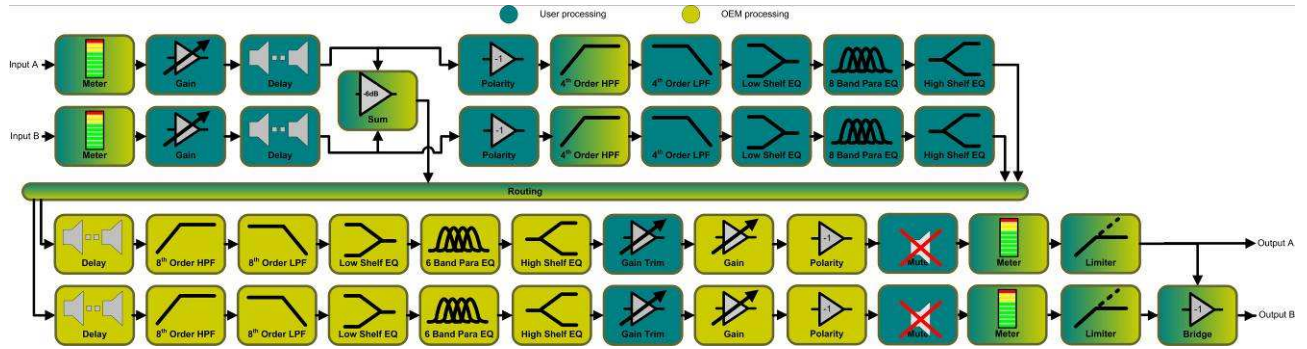



Technical Specifications

AUDIO

Input impedance	10k balanced
Max Input level	+20dBu
Frequency Response	20Hz - 20kHz+/-0.5dB @ 4 Ohm load
Output noise	-106dB A weighted Ref max output, 22kHz BW
Distortion	<0.05% (1kHz, -3dB output, 22kHz BW)

PROTECTION SYSTEMS

Output over current	Initially gain reduced to maintain control, extreme or persistent over current causes shutdown
Over temperature	limiters applied, persistent over temperature causes shutdown
Mains Brownout	Automatic protection & recovery
Switch on surge	Soft-start current inrush limiting
DC on output	Immediate shutdown, power cycle to recover

INDICATORS & CONTROLS

Indicators Per channel	Sig, Limit -6dB, Limit
Indicators Per channel pair	Power, Protect, Bridge, Network, User DSP active
Front panel controls:	
Per channel pair	User DSP Defeat - can be disabled with C-Net Power switch
Rear panel:	
Per channel pair	Contact closure inputs and Shutdown input (Aux)
Monitoring facilities	Input signal level, Output signal level Output current level Temperature Limiter operation Protection system operation Driver impedance

AMPLIFIERS

Type	High efficiency class D
Number of channels	Two / Four
Output power	(RMS program, 20Hz-20kHz all channels driven)
per channel	1,250W in to 2 Ohms 800W in to 4 Ohms 450W in to 8 Ohms
per bridged pair	2,500W in to 4 Ohms 1,600W in to 8 Ohms 900W in to 16 Ohms
Slew rate	>80V/us
Damping factor	120 ref 8 Ohms





Efficiency >90% typical

POWER SUPPLIES

Type High current, high freq. switch-mode

Number One / Two, fully independent

Efficiency >90% typical

Input voltage 115v / 230v nominal +/- 10%

* for 100v operation output figures please see separate specifications

Input voltage selection Automatic

Mains frequency range 45 - 65Hz

Other features Automatic soft-start

Automatic brownout recovery

Remote shutdown

Automatic over voltage protection

THERMAL

One variable speed fan per pair of channels and additionally one variable speed fan per unit

Airflow is from the rear to the front

ACCESSORIES

Airflow filtering kit

Rear rack support kit

PHYSICAL

Height 2RU, 88mm

Width 19", 482mm (front panel)

16.8", 427mm (rear chassis)

Depth 14", 360mm (behind rack)

1.4", 35mm (forward of rack)

Weight 20 pounds, 9 Kgs

Operating temperature range 0 to +40°C

Relative humidity range 0 to 80% (non-condensing)

CONNECTIONS

Mains (per C5) Neutrik 'Powercon'

Audio input (per channel) 3 pin female XLR

Audio link (per channel) 3 pin male XLR

Output (per channel) Neutrik NL4 'Speakon'

USB Type B (peripheral type)

Network (input & link) 2x RJ45 socket

Auxiliary (input & link) 2x RJ45 socket

*100v OPERATION

Output power 4 channels (RMS program, 20Hz-20kHz all channels driven)

4 x 945W in to 2 Ohms

4 x 605W in to 4 Ohms

4 x 340W in to 8 Ohms





Output power 2 bridged channels (RMS program, 20Hz-20kHz all channels driven)
per bridged pair 2 x 1890W in to 4 Ohms
 2 x 1210W in to 8 Ohms

Output power 3 channels (RMS program, 20Hz-20kHz all channels driven)
 2 x 945@2 Ohms + 1890W@4 Ohms
 2 x 605W@4 Ohms + 1890W@4 Ohms
 2 x 340@8 Ohms + 945W@8 Ohms

Recommended minimum operating voltage

230V range 155V
115V range 80V

Note that the range is automatically selected.

REGULATORY COMPLIANCE

This product complies with the EMC & LVD directives as issued by the Commission of the European Community. Compliance with these directives implies conformity with the following European standards:

- EN55103-1 Electromagnetic Interference (Emission)
- EN55103-2 Electromagnetic Susceptibility (Immunity)
- EN60065 Electrical safety

C5 also meets the requirements of FCC part 15B.

